



WRIGHT **STYLE**
LIMITED

curtain wall
& roof glazing
systems

specification
manual 1.1

Wright Style Ltd Curtain Wall Systems Technical Manual

Section 2 - Specification Manual

| Item | Page number(s) (click to go to) |
|--------------------------------------------------|--------------------------------------------|
| Index | 2 |
| Curtain wall material & tolerance specifications | 3 |
| Curtain wall system performance specifications | 4-6 |
| Ballistic information | 7 |
| Profile static value chart | 8 |
| Static value guide | 9-14 |
| U-value guide chart | 15 |
| Acoustic performance chart | 16 |

Curtain wall system component material & tolerance specification

Steel Grid Profiles

Material:

Mild steel to ST37-2 quality according to DIN 17100.
(Equivalent to S235 JRG2 quality according to EN10025)

Stainless steel to 1.4301 & 1.4404 quality according to DIN 17440
(Equivalent to 304 & 316L quality to AISI standards)

Sendzimir galvanising of interior and exterior of profiles to 275g/m² according to EN10142
(Where applicable)

Tolerances:

Length tolerance of profiles according to DIN EN10162 is +50mm / -0mm.

Cross sectional profile tolerance is 0.8% profile depth according to DIN ISO 2768

Aluminium Pressure Plate / Capping Profiles

Material:

Aluminium alloy to eloxadisable ALMgSi0.5 according to DIN 1747 and DIN17615.
(Equivalent to 6063-T6 to BSEN573-3)

Tolerances:

Length tolerance of profiles according to DIN EN10162 is +50 / -0mm.

Cross sectional profile tolerance is 0.25mm according to BSEN1474.

System Gaskets

Material:

EPDM non-cellular elastomer compound to DIN EN 7863 &. (Equivalent to BS3734).

Tolerances:

Length tolerance of +50mm / -0mm to DIN EN 7715. (Equivalent to BS3734).

Cross sectional tolerance to 0.3mm to DIN EN 7715. (Equivalent to BS3734 - E1).

System screws

Material:

Zinc coated 1.4301 stainless steel according to DIN EN17440 (Equivalent to 304 quality to AISI standards).

Tolerances:

Length tolerance to DIN EN 7970

Cross sectional tolerance to DIN EN 7976

Curtain wall & Roof glazing system performance specifications

Fire Rated Curtain Walling

Fire rated for up to 2 hours integrity only and integrity & insulation.
Certified for use with any fire rated glass (subject to glass test evidence).
Unlimited pane sizes (pane sizes dictated by tested glass used).
System must be fixed at a minimum 4500mm vertical centres.
Pressure plate screws must be at a minimum of 250mm centres.
Aluminium or steel glass supports may be used (subject to fire rating)
Gasket or tape glazing may be used.
All 60 series system profiles may be used.
Aluminium capping profiles may be used.
Unique system heat isolator used for insulated specifications.
System may be mechanically jointed, or fully welded construction.
System arrangement remains the same regardless of fire rating.

(for further detailed information, refer to global assessment set or local test evidence)

Fire Rated Roof Glazing

Fire rated for up to 1 hour integrity only and integrity & insulation.
Certified for use with any fire rated glass (subject to glass test evidence).
Gasket or tape glazing may be used.
Certified for pitches of 15 to 80 degrees from the horizontal.
Rafter centres must be fixed at a minimum 1500mm centres.
Pressure plate screws must be at a minimum of 250mm centres.
Aluminium or steel glass supports may be used (subject to fire rating)
All 60 series system profiles may be used.
Aluminium capping profiles may be used.
Unique system heat isolator used for insulated specifications.
System may be mechanically jointed, or fully welded construction.
System arrangement remains the same regardless of fire rating.

(for further detailed information, refer to global assessment set or local test evidence)

Ballistic Resistant Curtain Walling:

Framing tested for all classifications under BS5051 from specifications G0 through to R2 including armour piercing specifications. (see table on page 34)
Specified glass used must have the required edge cover as per glass test data.
System can provide up to 25mm edge cover.
Inserts should be used if profile wall thickness is less than 4mm.
Inserts should be used if specification is armour piercing.

(for further detailed examples and specification table see page 34)

Curtain wall & Roof glazing system performance specifications

Blast Resistant Curtain Walling & Roof Glazing

Physical testing has been performed on the system, but it is not publicly available due to the sensitive nature of the clients.

Compliance to a specification can be shown by way of structural calculations in conjunction with glass test evidence, where the glass interface detail must be followed including structural glazing type, edge cover etc.

Standard edge cover on the curtain wall systems can be provided up to 25mm. Through the use of add-on profiles the system can accommodate larger edge covers of up to 50mm.

(note: Due to the complex nature of the specification, blast systems have to be reviewed on a case by case basis as there is no 'standard detail' For further assistance, please contact Wright Style.)

Large Span Curtain Walling & Roof Glazing

Spans of over 12 metres have been achieved using our steel grid profile systems.

Extremely high static values of the system profiles mean that these spans can be achieved without the use of additional supports or trusswork. (static value charts shown on page 35)

Quotations can be provided using experience of previous projects but full calculations should be done by a certified structural engineer.

This will take into account all wind loadings, dead loads, line loads, fixing requirements and local deflection criteria. (This is provided at an extra cost)

Thermal Performance (Including Document L)

Due to the thermally broken nature of the system arrangement, previous thermal analysis have proven that the standard system arrangement can provide U-values as low as 0.9W/m²K when used in conjunction with a high performance glass.

Compliance to a thermal (or Document L) specification must be shown by an analysis of a particular system arrangement, taking into account the entire assembly and components.

Analysis has been carried out in accordance with EN10077 on the curtain wall system, but as every project is different this can only be used as a guide as to what the system achieves in relation to the size and configuration of the assembly and the centre pane value of the glass. (please refer to page 36 for U-value chart)

Actual case by case or specific project analysis should be carried out by the system fabricator with data to back this up by a certified body.

Acoustic Performance

The sound reduction performance of a façade is dictated by a number of factors, which individually can have different effects. Unfortunately these factors cannot be easily summarised into different formats. The system should be chosen and tested on a case-by case basis by a certified laboratory. Just the slightest change in arrangement, profiles and glass make-ups can have a dramatic effect on the overall performance of the façade.

However, we can offer a guide based on previous testing of our systems.

Based on test results conducted in accordance with DIN52210 (equivalent of BS8233), when used in conjunction with an acoustic performing glass the systems can achieve a dB reduction of up to 42dB. (please refer to page 37 for table of test results)

Curtain wall & Roof glazing system performance specifications

Weather performance

Performance testing undertaken on the systems have been undertaken to DIN standards but have been subsequently assessed by an approved authority to BS equivalents as follows:

Air infiltration test - Tested up to 600Pa with no failure (Grade A4 EN12152)
(BS5368 P1)

Water penetration test - Tested up to 600Pa with no failure (Grade R4 EN12154)
(BS5368 P2)

Wind resistance test - Tested up to 1320 Pa followed by 50 cycles at +/- 1000 Pa with no failure.
(BS5368 P3)

Safety test - Short term 15 second pulse of 2000 Pa with no failure or physical change.

Coating specifications

Coating of steel profiles can be achieved by way of numerous methods including air-drying, multi-coat or for a better result thermo hardened powder coating.

For the actual method of preparation and coating should be dictated by the nominated coating company to be in compliance with their own warranty, however, as a guide the systems have undergone acid-salt testing with the following procedure:

Where profile surface has been damaged by cutting, welding or other, re-dress by blasting to SA2 1/2 and apply with zinc metal to 75-100 microns.

Profiles should then be de-gassed and T-washed before application of powder coating to a thickness of 60 microns.

Through this method the system was exposed to an acetic acid-salt spray fog as described in BS6497 clause 4.7 for a continuous period of 500 hours without any resulting surface degradation.

(note: For T & Davex profiles, additional surface treatments such as sand-blasting may be required, dependant on the finish required).

(note: For aluminium profiles, standard acceptable methods of coating may be used)

| BS 5051 BALLISTIC CLASSIFICATIONS | | | | | | | |
|-----------------------------------|----------------------|-------------------------------------------------------|------------------------------|----------|--------------|-----------------|-------------------------------|
| CLASS | FIREARM AND CALIBRE | AMMUNITION | VELOCITY PER METRE SEC / MAX | RANGE | No OF ROUNDS | GLASS THICKNESS | GLASS/POLYCARBONATE THICKNESS |
| G0 | 9mm MILITARY HANDGUN | 9mm MK2Z STANDARD 7.5 GRAMS | 390 | 3METRES | 3 | 20mm | 19mm |
| G1 | .357 MAGNUM HANDGUN | SOFT POINT 158 GRAIN SEMI JACKET FLAT NOSE 10.2 GRAMS | 435 | 3METRES | 3 | 28mm | 23mm |
| G2 | .44 MAGNUM HANDGUN | SOFT POINT 240 GRAIN SEMI JACKET FLAT NOSE 10.2 GRAMS | 456 | 3METRES | 3 | 35mm | 24mm |
| S86 | 12 BORE SHOTGUN | SOLID LEAD SLUG 28.35 GRAMS RIFLED | 406 | 10METRES | 1 | 35mm | 24mm |
| R1 | 5.56mm RIFLE | NATO STANDARD 5.56mm BALL ROUND SS109 4 GRAMS | 919 | 10METRES | 3 | 42mm | 40mm |
| R2 | 7.62 SLR RIFLE | NATO STANDARD 7.62mm BALL ROUND 9.5 GRAMS | 815 | 10METRES | 3 | 48mm | 40mm |

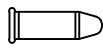

9mm MILITARY HANDGUN

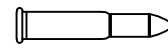

5.56mm RIFLE

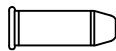

.375 MAGNUM HANDGUN

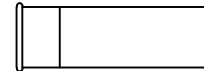

12 BORE SHOTGUN

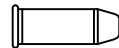

.44 MAGNUM HANDGUN

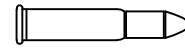

7.62 SLR RIFLE

CURTAIN WALL SECTIONS OF 4MM AND GREATER, RATED TO R2 CLASSIFICATION.

FOR CURTAIN WALL SECTIONS LESS THAN 4MM, ADD H10147 BALLISTIC PROFILE, FOR CLASSIFICATION UP TO R2 AND ARMOUR PIERCING APPLICATIONS.

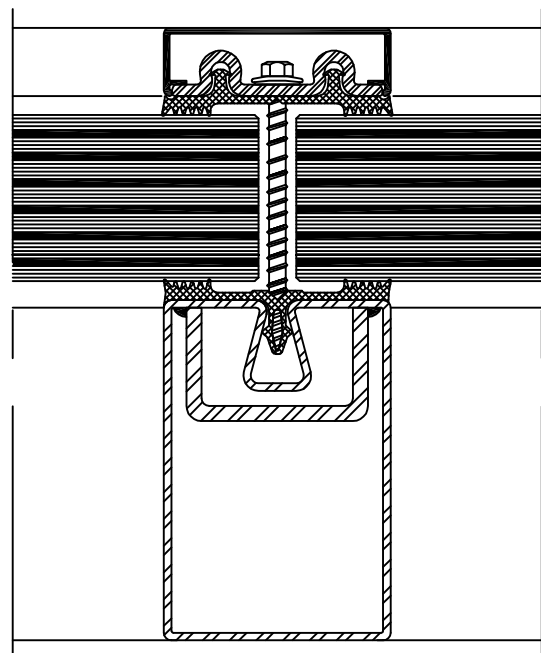
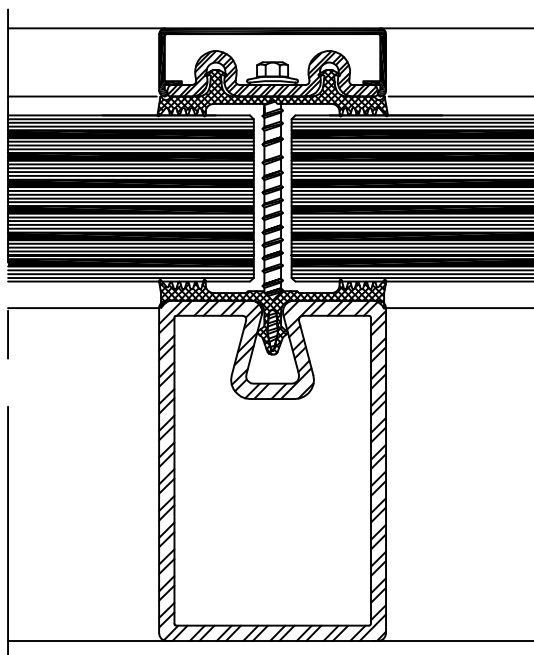

| Profile No | Height mm | Width mm | Thickness mm | Weight kg/m | A cm ² | I _{xx} cm ⁴ | Z _{xx} cm ³ | r _{xx} cm | I _{yy} cm ⁴ | Z _{yy} cm ³ | r _{yy} cm |
|-------------------|--------------|-------------|-----------------|----------------|----------------------|------------------------------------|------------------------------------|-----------------------|------------------------------------|------------------------------------|-----------------------|
| SR5040-2 | 40 | 50 | 2 | 3.43 | 4.37 | 8.69 | 4.21 | 1.410 | 12.34 | 4.94 | 1.680 |
| SR5090-2 | 90 | 50 | 2 | 5.00 | 6.37 | 64.93 | 13.14 | 3.193 | 23.87 | 9.55 | 1.936 |
| SR50120-2 | 120 | 50 | 2 | 5.94 | 7.57 | 134.77 | 20.51 | 4.219 | 30.79 | 12.36 | 2.017 |
| SR50150-3 | 150 | 50 | 3 | 10.25 | 13.06 | 349.53 | 42.82 | 5.173 | 54.13 | 21.65 | 2.036 |
| SR6040-2 | 40 | 60 | 2 | 3.74 | 4.77 | 18.96 | 4.93 | 1.458 | 10.14 | 6.32 | 1.994 |
| SR6060-2 | 60 | 60 | 2 | 4.37 | 5.57 | 26.81 | 8.30 | 2.194 | 25.70 | 8.56 | 2.148 |
| SR6090-2 | 90 | 60 | 2 | 5.31 | 6.77 | 72.75 | 14.80 | 3.278 | 35.79 | 11.93 | 2.299 |
| SR6090-4 | 90 | 60 | 4 | 10.10 | 12.86 | 129.15 | 26.54 | 3.169 | 63.83 | 26.54 | 2.228 |
| SR9090-3 | 90 | 90 | 3 | 10.09 | 12.85 | 131.25 | 28.64 | 3.196 | 131.25 | 28.64 | 3.196 |
| SR60130-D | 130 | 60 | 3 | 8.80 | 11.21 | 191.83 | 24.29 | 4.137 | 49.26 | 16.42 | 2.096 |
| SR60140-2 | 140 | 60 | 2 | 6.88 | 8.77 | 219.00 | 28.78 | 4.997 | 52.61 | 17.54 | 2.449 |
| SR60140-4 | 140 | 60 | 4 | 13.24 | 16.86 | 400.79 | 53.07 | 4.876 | 95.25 | 31.75 | 2.377 |
| SR60180-T3 | 180 | 60 | 3 | 12.75 | 16.24 | 555.59 | 52.27 | 5.849 | 29.19 | 9.73 | 1.341 |
| SR60180-3 | 180 | 60 | 3 | 12.14 | 15.46 | 608.40 | 62.67 | 6.273 | 95.50 | 31.83 | 2.485 |
| SR60180-5 | 180 | 60 | 5 | 19.55 | 24.91 | 940.15 | 97.48 | 6.143 | 144.90 | 48.31 | 2.412 |
| T5050 | 50 | 50 | 8 | 5.94 | 7.56 | 16.61 | 4.77 | 1.482 | 8.76 | 3.50 | 1.076 |
| T5080 | 80 | 50 | 8 | 7.82 | 9.96 | 63.48 | 12.02 | 2.525 | 8.89 | 3.56 | 0.945 |
| T6060 | 60 | 60 | 8 | 7.23 | 9.21 | 29.83 | 7.04 | 1.80 | 15.06 | 5.02 | 1.279 |
| T6090 | 90 | 60 | 8 | 9.11 | 11.60 | 93.89 | 15.51 | 2.85 | 15.10 | 5.03 | 1.140 |
| T60120 | 120 | 60 | 10 | 13.53 | 17.23 | 252.24 | 32.85 | 3.826 | 19.12 | 6.37 | 1.053 |
| T60120R | 120 | 60 | 8/10 | 14.15 | 18.03 | 332.43 | 48.29 | 4.29 | 20.53 | 6.84 | 1.07 |
| T60180R | 180 | 60 | 8/10 | 21.37 | 27.22 | 1164.99 | 126.07 | 6.542 | 27.02 | 9.00 | 0.998 |
| DT60120 | 120 | 60 | 3 | 11.78 | 15.00 | 389.00 | 64.83 | 5.09 | 36.02 | 12.01 | 1.55 |
| DTL60120 | 120 | 60 | 3 | 10.99 | 14.00 | 380.68 | 63.45 | 5.21 | 36.02 | 12.01 | 1.60 |
| DT60180 | 180 | 60 | 3 | 13.19 | 16.80 | 970.40 | 107.82 | 7.60 | 36.04 | 12.01 | 1.46 |
| DTL60180 | 180 | 60 | 3 | 11.93 | 15.20 | 936.30 | 104.03 | 7.85 | 36.02 | 12.01 | 1.54 |
| DT60200 | 200 | 60 | 3 | 13.66 | 17.40 | 1229.80 | 122.98 | 8.41 | 36.04 | 12.01 | 1.44 |
| DTL60200 | 200 | 60 | 3 | 12.25 | 15.60 | 1181.25 | 118.12 | 8.70 | 36.03 | 12.01 | 1.52 |

Curtain wall profile selection guide

Curtain wall grid profiles should be selected according to the span & windload specification on the desired application.

This should be done by a certified structural engineer who can take into account all variables and safety factors that should be considered.

However, this can be expensive at time of tender, and so as a guide we have produced a series of charts to enable the user to select the minimum profile size required to achieve the span.

- 1) Select the desired chart according to the approximate mullion span. Eg: 4000mm between floor fixing & head fixing.
- 2) Find the mullion grid centres along the bottom of the chart: Eg: 1200mm centre to centre.
- 3) Line this up and across to the required Ixxcm⁴ of profile: Eg: Approx 115cm⁴.
- 4) Refer to the table at the base of the page for Ixx values of each profile, or on the following page for combination profiles. Profile cm⁴ needs to be the same or higher than the value given on the chart: Eg: SR6090-4 with 129.15cm⁴ will be sufficient for this example.

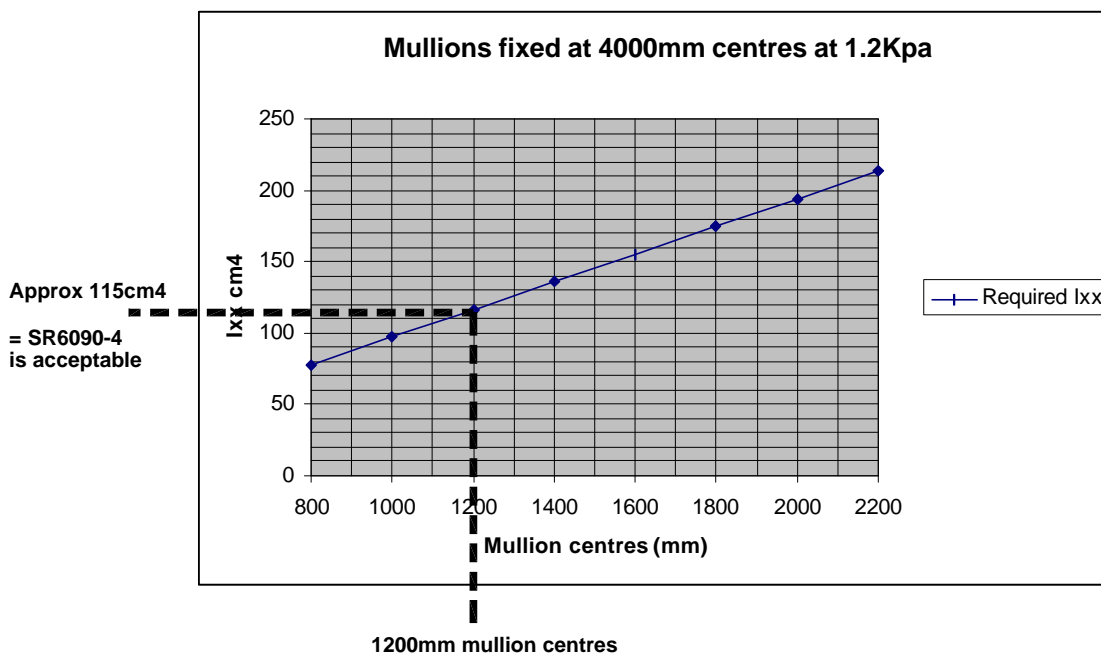

Stand alone mullion profiles

| Profile No | Ixx cm ⁴ |
|------------|---------------------|
| SR6040-2 | 18.96 |
| SR6060-2 | 26.81 |
| SR6090-2 | 72.75 |
| SR6090-4 | 129.15 |
| SR9090-3 | 131.25 |
| SR60130-D | 191.83 |
| SR60140-2 | 219.00 |
| SR60140-4 | 400.79 |
| SR60180-T3 | 555.59 |
| SR60180-3 | 608.40 |
| SR60180-5 | 940.15 |

| Profile No | Ixx cm ⁴ |
|------------|---------------------|
| SR5040-2 | 8.69 |
| SR5090-2 | 64.93 |
| SR50120-2 | 134.77 |
| SR50150-3 | 349.53 |
| T5050 | 16.61 |
| T5080 | 63.48 |
| T6060 | 29.83 |
| T6090 | 93.89 |
| T60120 | 252.24 |
| T60120R | 332.43 |
| T60180R | 1164.99 |

| Profile No | Ixx cm ⁴ |
|------------|---------------------|
| DT60120 | 389.00 |
| DTL60120 | 380.68 |
| DT60180 | 970.40 |
| DTL60180 | 936.30 |
| DT60200 | 1229.80 |
| DTL60200 | 1181.25 |

Mullion profiles with support

| Profile No | With support profile No | Ixx cm4 |
|------------|-------------------------|---------|
| SR6090-4 | T60180R | 2933 |
| SR6090-4 | T60120R | 1153 |
| SR6090-4 | T6090 | 566 |
| SR6090-4 | DT60200 | 2914 |
| SR6090-4 | DT60180 | 2427 |
| SR60140-2 | T60180R | 3125 |
| SR60140-2 | T60120R | 1415 |
| SR60140-2 | T6090 | 812 |
| SR60140-2 | DT60200 | 3134 |
| SR60140-2 | DT60180 | 2665 |
| SR60140-4 | T60180R | 4298 |
| SR60140-4 | T60120R | 2009 |
| SR60140-4 | T6090 | 1182 |
| SR60140-4 | DT60200 | 4105 |
| SR60140-4 | DT60180 | 3525 |
| SR60180-3 | T60180R | 5039 |
| SR60180-3 | T60120R | 2596 |
| SR60180-3 | T6090 | 1657 |
| SR60180-3 | DT60200 | 4794 |
| SR60180-3 | DT60180 | 4187 |
| SR60180-5 | T60180R | 8299 |
| SR60180-5 | T60120R | 3352 |
| SR60180-5 | T6090 | 2174 |
| SR60180-5 | DT60200 | 5868 |
| SR60180-5 | DT60180 | 5161 |

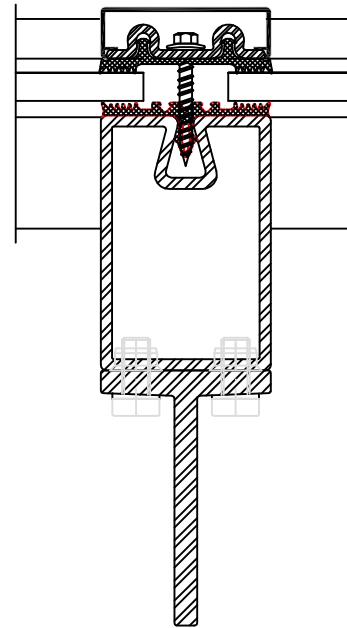

Profile No
SR6090-4
with T6090
support

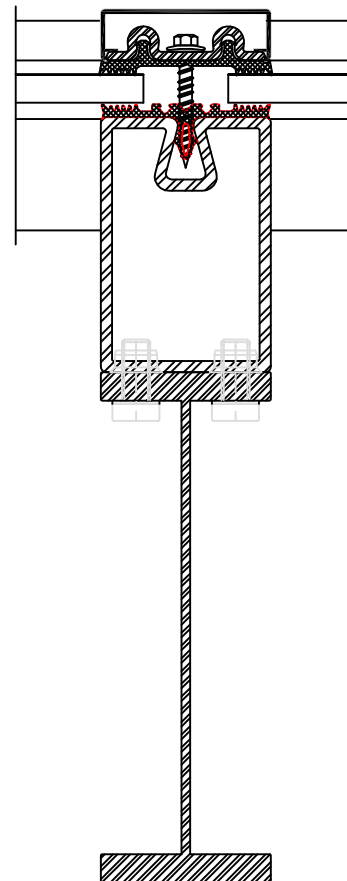

Profile No
SR6090-4
with DT60180
support

Note:

All static value information is provided on this page and the following pages as a guide only. It remains the ultimate responsibility of the system fabricator to ensure structural calculations from an approved structural engineer are provided on a project by project basis and that the system is suitable for the proposed application.

We cannot accept responsibility for the application of this information.

Mullions fixed at 3000mm vertical centres at 1.2Kpa

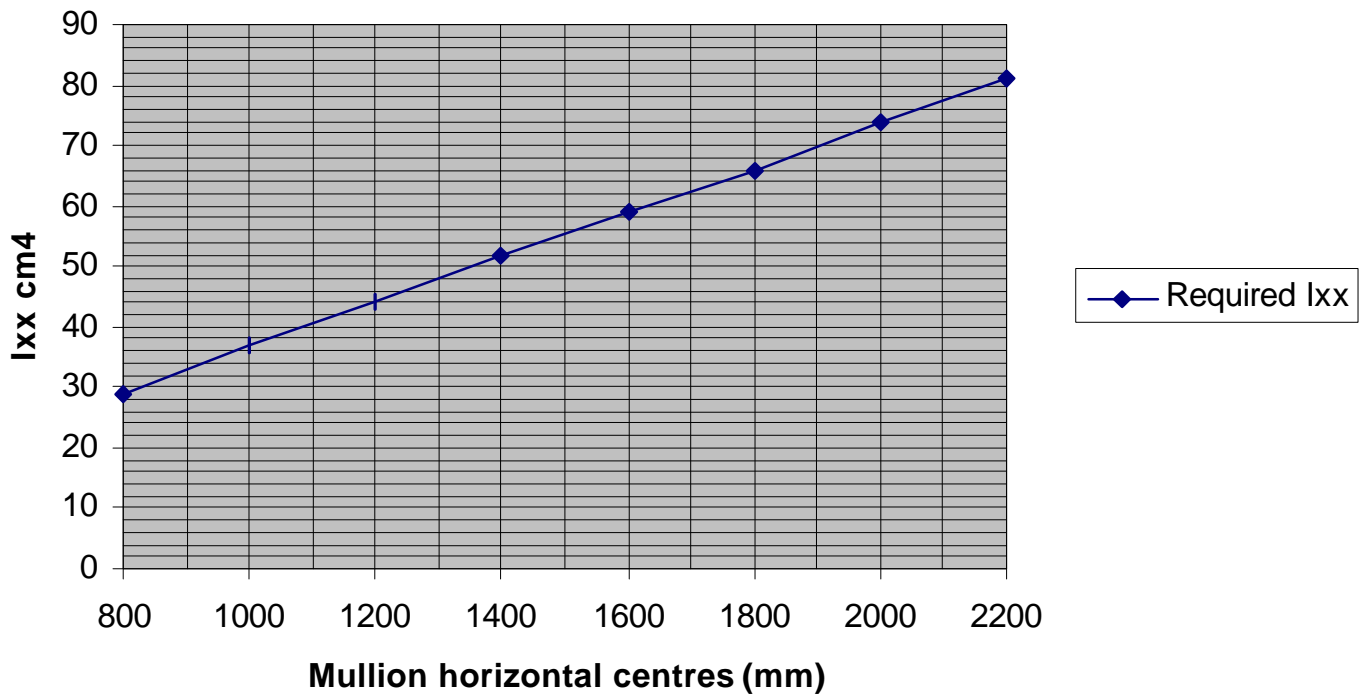

Mullions fixed at 4000mm vertical centres at 1.2Kpa

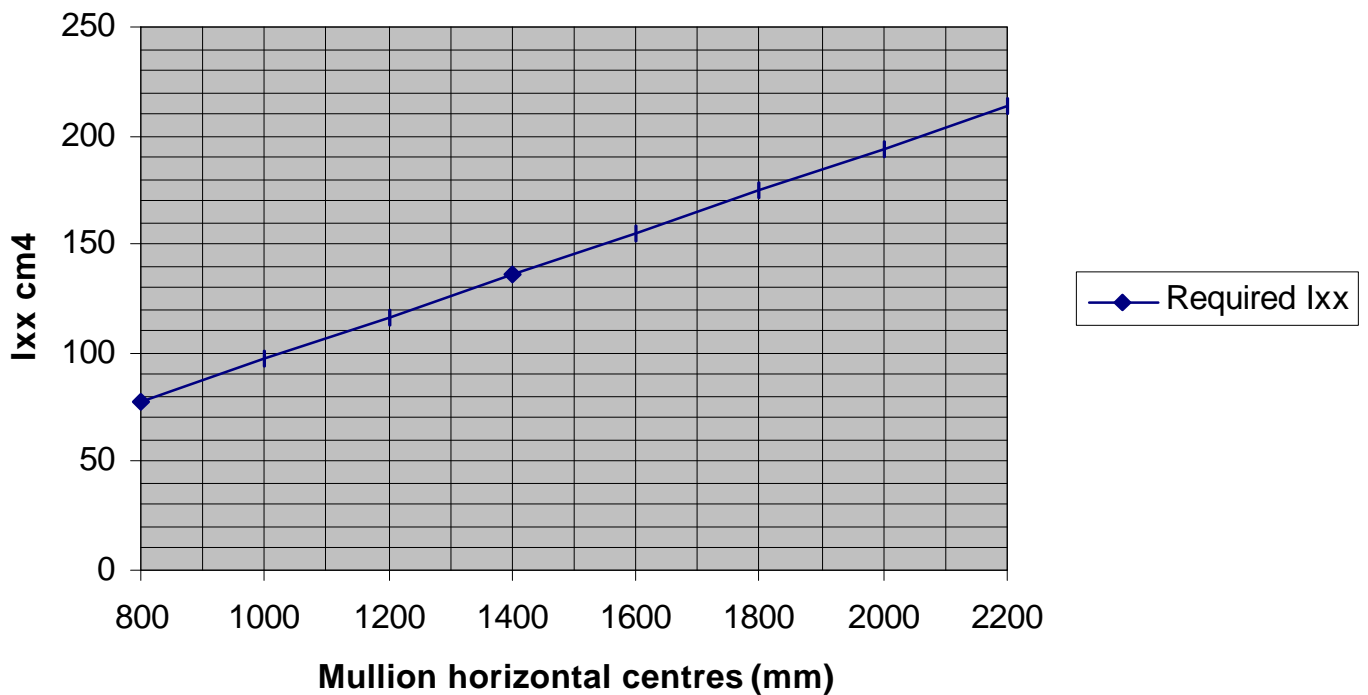

Mullions fixed at 5000mm vertical centres at 1.2Kpa

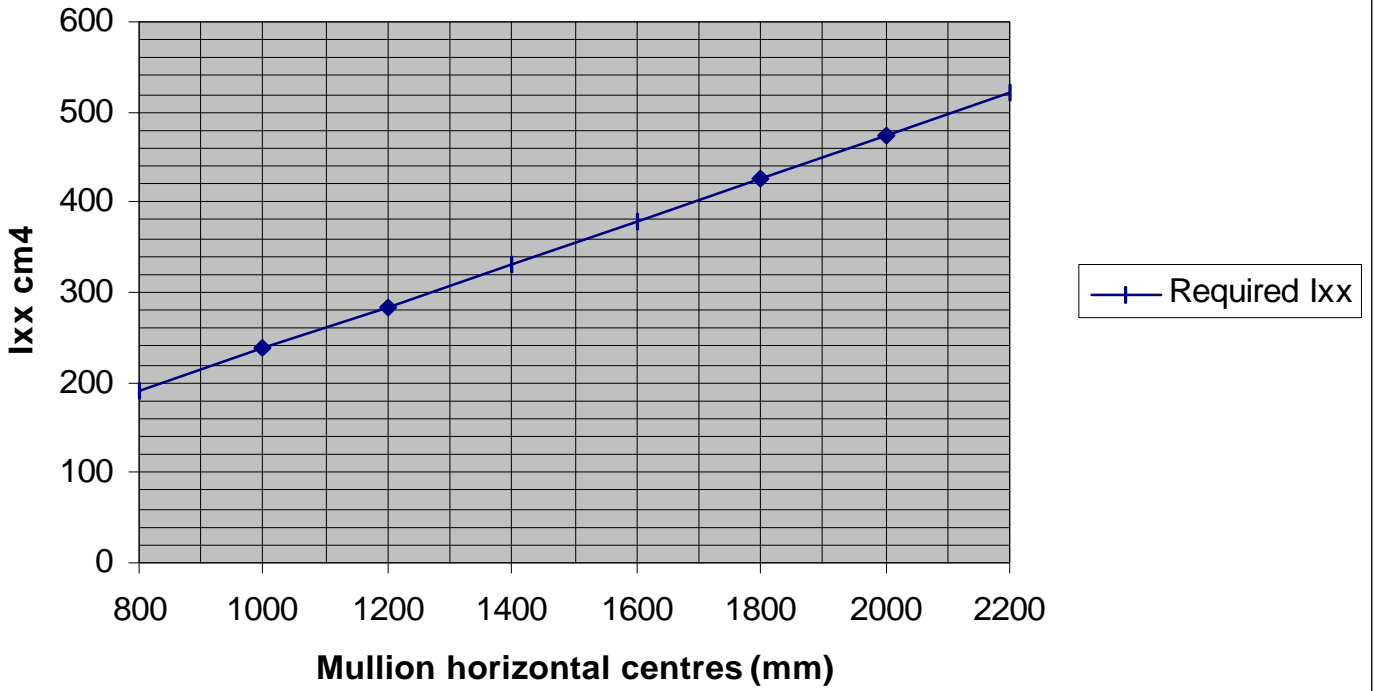

Mullions fixed at 6000mm vertical centres at 1.2Kpa

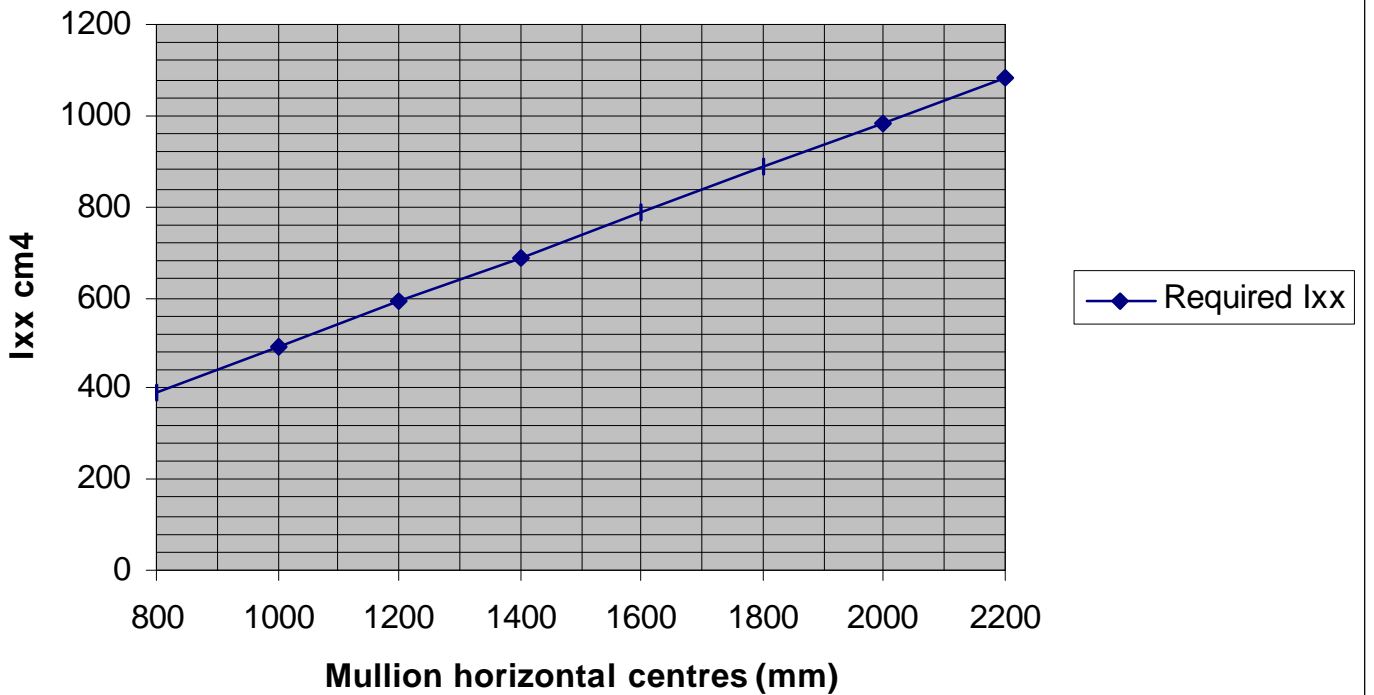

Mullions fixed at 7000mm vertical centres at 1.2Kpa

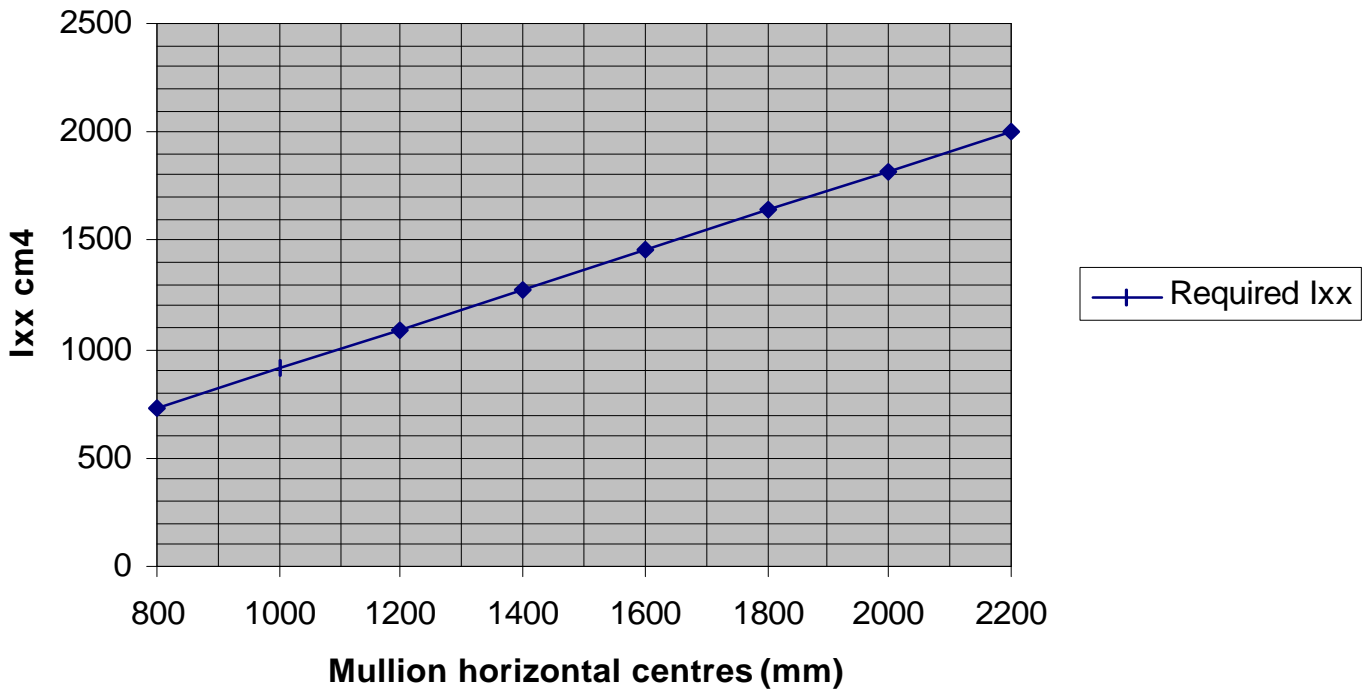

Mullions fixed at 8000mm vertical centres at 1.2Kpa

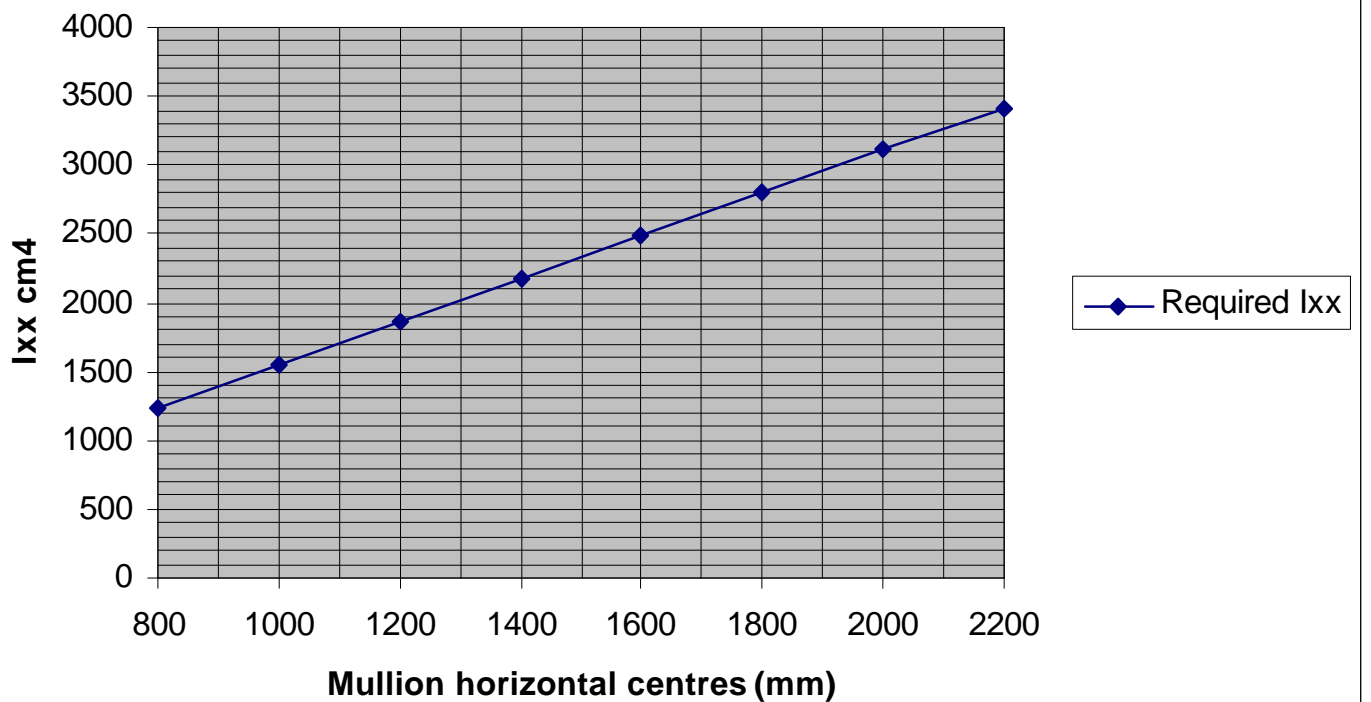

Mullions fixed at 9000mm vertical centres at 1.2Kpa

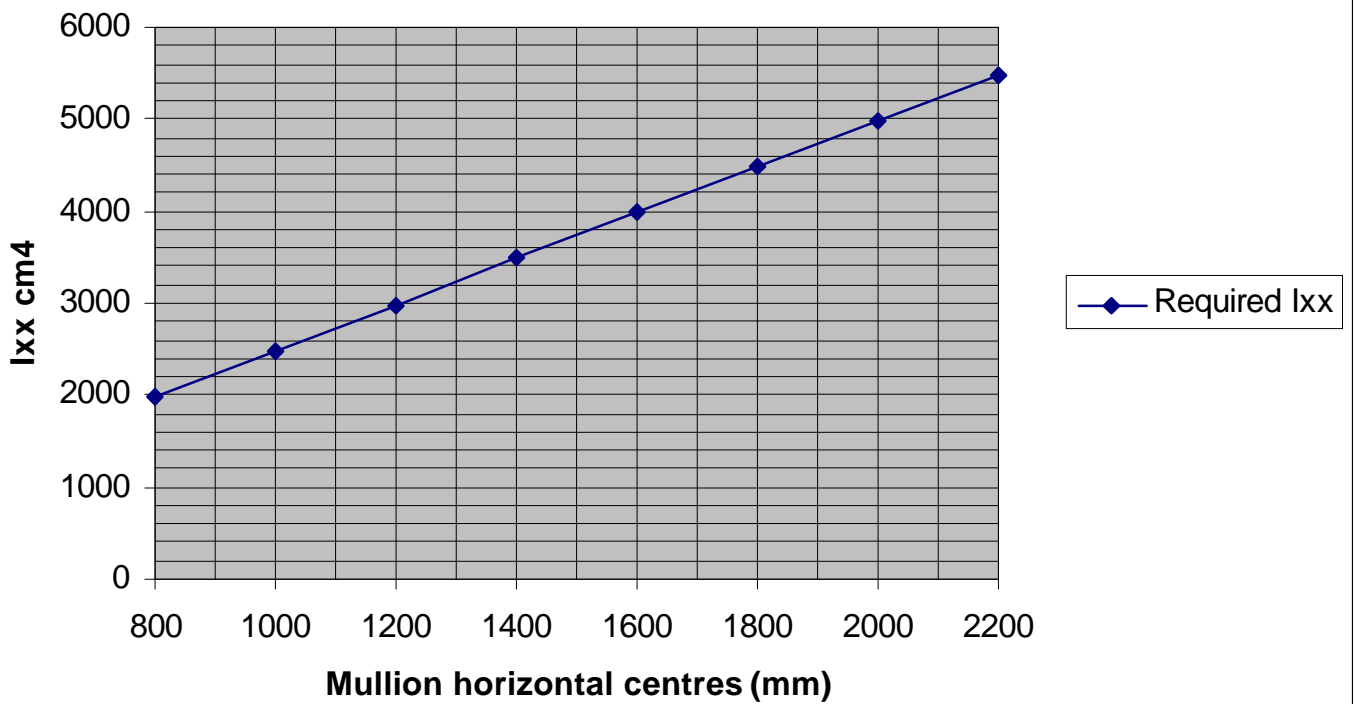

Thermal insulation performance W/m²K

Below are guide tables to indicate the performance with different arrangements of the curtain wall framing in conjunction with various glass types with different centre pane values.

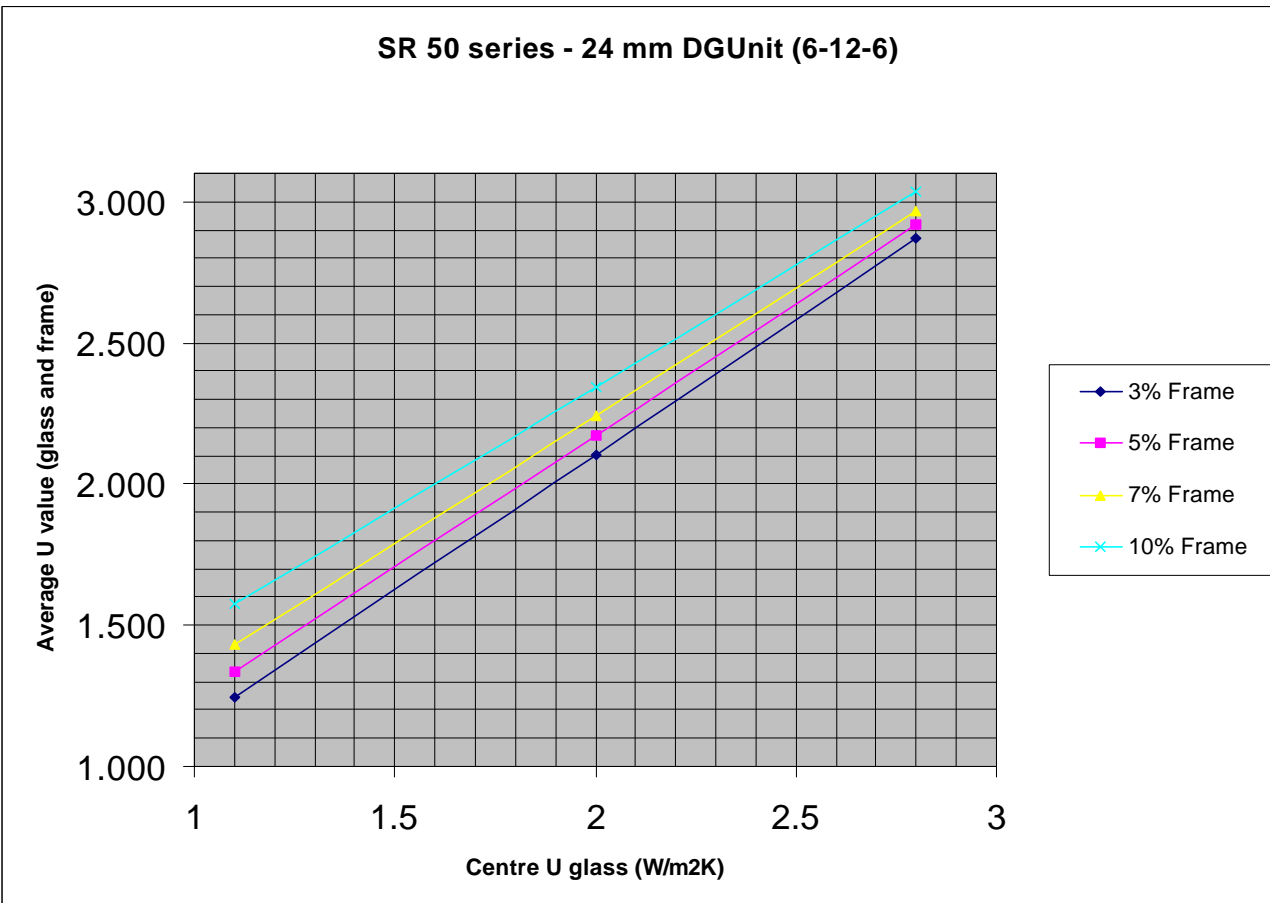
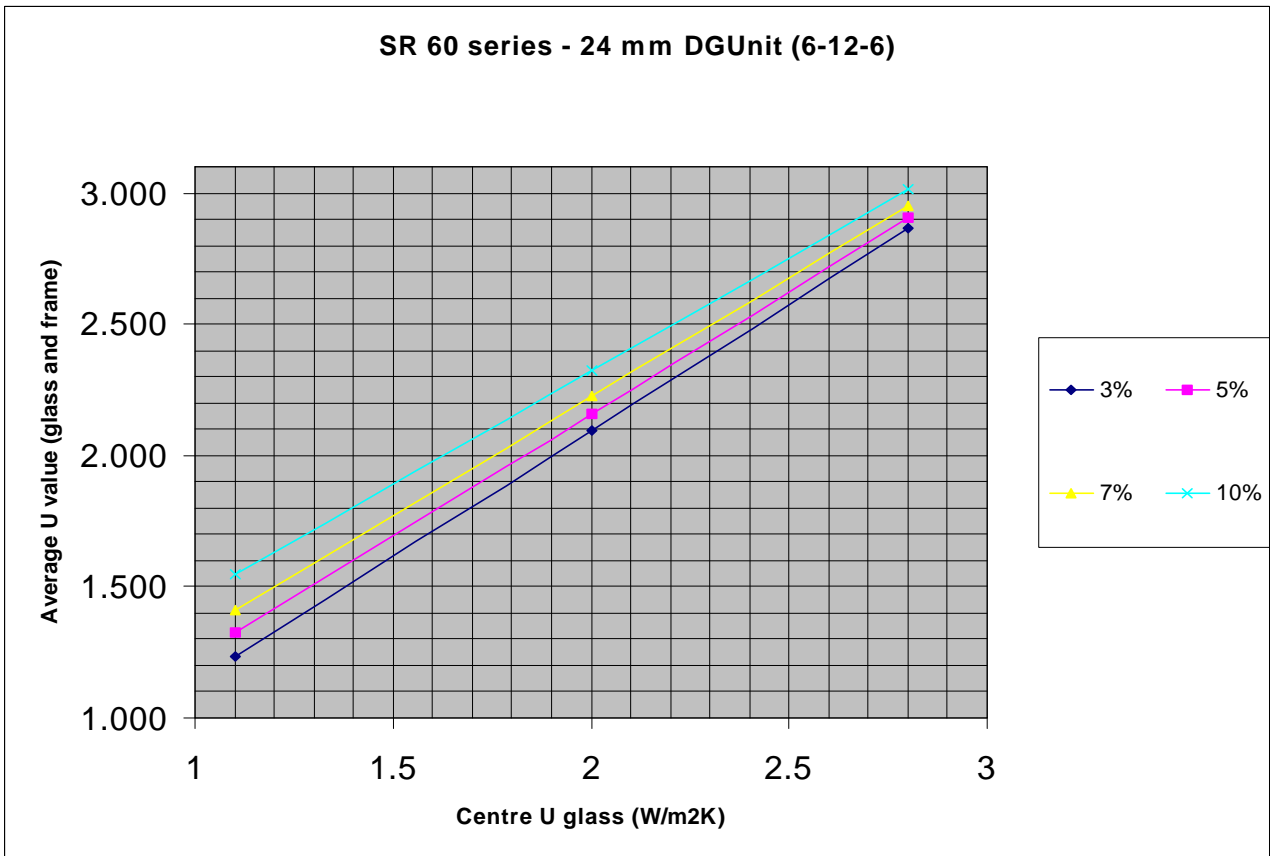

Evaluated sound insulation measurement *R_w*:

For the evaluation of sound insulation of facades the measurement is given in the term *R_w*. *R_w* values are laboratory sound insulation measurements according to DIN52210.

| Profile | | Glass makeup Inner/Spacer/Outer | Test <i>R_w</i> | Calculated <i>R_w</i> | VDI Class Grade | Test report number |
|----------|------------|------------------------------------|------------------------------|------------------------------------|--------------------|-----------------------|
| Vertical | Horizontal | | | | | |
| SR6090 | SR6090 | 6/12/6 | 33dB | 33dB | 2 | 161 17267/1.0.0 |
| SR6090 | SR6090 | 9/16/6 Gas filled | 40dB | 40dB | 3 | 161 17267/1.3.0 |
| SR6090 | SR6090 | 9/24/6 Gas filled | 42dB | 42dB | 4 | 161 17267/1.5.0 |

| Sound insulation grade according to VDI-guideline 2719 | Evaluated sound insulating measurement <i>R_w</i> of the on-site element to DIN 52210 P5 in dB | Compulsory evaluated sound insulating measurement <i>R_w</i> of the test assembly to DIN 52210 P2 in dB |
|--------------------------------------------------------|----------------------------------------------------------------------------------------------------------|-------------------------------------------------------------------------------------------------------------------|
| 1 | 25 to 29 | > 27 |
| 2 | 30 to 34 | > 32 |
| 3 | 35 to 39 | > 37 |
| 4 | 40 to 44 | > 42 |
| 5 | 45 to 49 | > 47 |
| 6 | > 50 | > 52 |

Sound measurement curves:

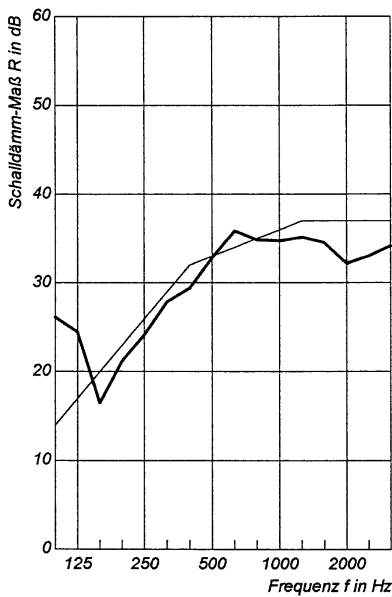

161 17267/1.0.0

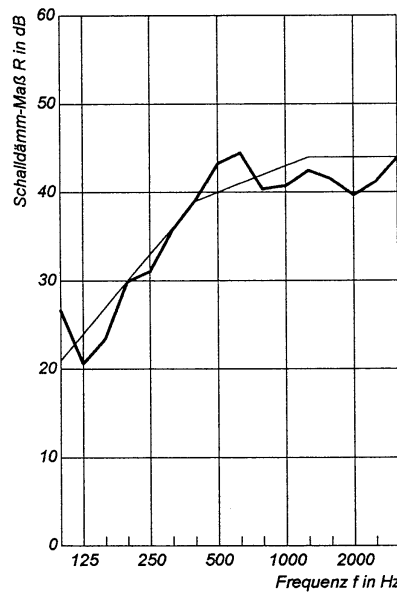

161 17267/1.3.0

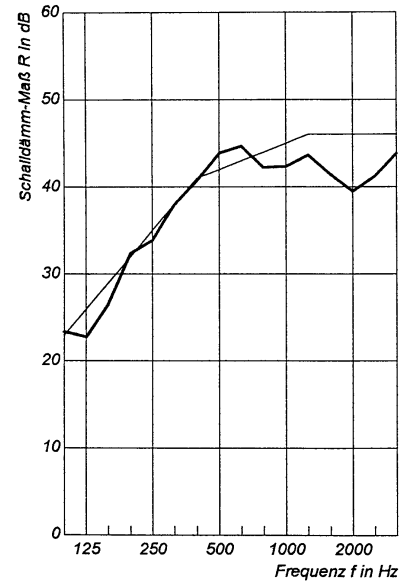

161 17267/1.5.0

— Reference curve
 — Actual measurement

Note:- Measurements apply to both SR & T systems